

SIANK465

INSTALLATION MANUAL



Fe: min 0,61 mm



INCLUDED IN THE PACKAGE

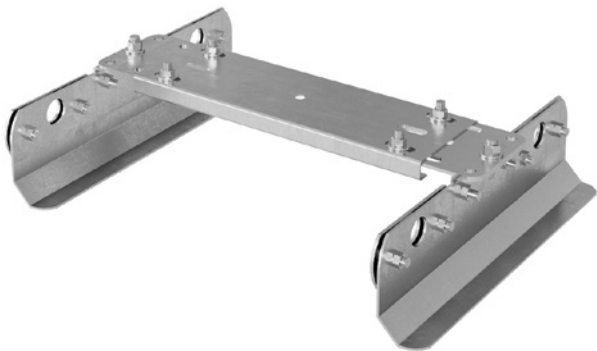

EN
795:2012
A + C

CEN/TS
16415:2013

UNI
11578:2015
A + C



TOOLS



SAFETY INSTRUCTIONS

- IT** L'installazione e/o utilizzo del prodotto Rotho Blaas è permessa solo a personale esperto previa lettura e comprensione del **1** **MANUALE D'INSTALLAZIONE** e delle **2** **NORME DI SICUREZZA** nella lingua del relativo Paese di utilizzo.
- DE** Die Installation und/oder die Verwendung des Produkts von Rotho Blaas ist ausschließlich Fachpersonal vorbehalten, nachdem es die **1** **INSTALLATIONSHANDBUCH** und die **2** **SICHERHEITSVORSCHRIFTEN** in der Sprache des Verwendungslandes gelesen und verstanden hat.
- EN** Only qualified personnel may install and/or use this Rotho Blaas product, after reading and understanding the **1** **INSTALLATION MANUAL** and the **2** **SAFETY REGULATIONS**, in the language of the country of use.
- ES** La instalación y/o el uso del producto Rotho Blaas solo están permitidos al personal experto después de haber leído y comprendido la **1** **MANUAL DE INSTALACIÓN** y las **2** **NORMAS DE SEGURIDAD** en el idioma del país en el que se utiliza.
- FR** Seul le personnel expérimenté peut installer et/ou utiliser ce produit Rotho Blaas, après avoir lu et compris les **1** **MANUEL D'INSTALLATION** et les **2** **NORMES DE SÉCURITÉ** dans la langue du pays où le produit est utilisé.
- PT** A instalação e/ou utilização do produto RothoBlaas só é permitida a pessoal especializado após a leitura e compreensão das **1** **INFORMAÇÕES NECESSÁRIAS** e das **2** **NORMAS DE SEGURANÇA** na língua do respetivo país onde será utilizado.
- RU** К установке и (или) использованию продукции Rotho Blaas допускается только высококвалифицированный персонал после обязательного прочтения и усвоения **1** **РУКОВОДСТВО ПО УСТАНОВКЕ** и **2** **ПРАВИЛ ТЕХНИКИ БЕЗОПАСНОСТИ** на языке соответствующей страны использования.
- CS** Instalace a/nebo použití výrobku Rotho Blaas je povoleno pouze odborným osobám po přečtení a pochopení **1** **NÁVODU K INSTALACI** a **2** **BEZPEČNOSTNÍCH PŘEDPISŮ** v jazyce příslušné země použití.
- DA** Kun kvalificeret personale må installere og/eller bruge dette Rotho Blaas-produkt efter at have læst og forstået den **1** **INSTALLATIONSMANUALEN** og **2** **SIKKERHEDSFORSKRIFTERNE** på brugerens sprog.
- EL** Η εγκατάσταση ή/και η χρήση του προϊόντος Rotho Blaas επιτρέπεται μόνο σε έμπειρο προσωπικό που έχει διαβάσει και κατανοήσει τις **1** **ΕΓΧΕΙΡΙΔΙΟ ΕΓΚΑΤΑΣΤΑΣΗΣ** και τους **2** **ΚΑΝΟΝΙΣΜΟΥΣ ΑΣΦΑΛΕΙΑΣ** στη γλώσσα της σχετικής χώρας χρήσης.
- ET** Antud Rotho Blaasi toodet tohib paigaldada ja / või kasutada ainult kvalifitseeritud personal, kes on lugenud kasutamise riigi keeles **1** **PAIGALDUSJUHENDIS** ja **2** **OHUTUSEESKIRJU** ning nendest aru saanud.
- FI** Tämän Rotho Blaas -tuotteen asennus ja/tai käyttö on sallittu vain asiantuntevan henkilöstön toimesta sen jälkeen, kun he ovat lukeneet ja ymmärtäneet **1** **ASENNUSOHJEIDEN** ja **2** **TURVALLISUUSMÄÄRÄYKSET** käyttömaan kielellä.
- HR** Postavljanje i/ili uporaba proizvoda Rotho Blaas dopuštena je samo stručnom osoblju koje je prethodno pročitalo i razumjelo **1** **UPUTA ZA MONTAŽU** kao i **2** **PROPISE O SIGURNOSTI** na jeziku zemlje uporabe.
- HU** A Rotho Blaas terméket kizárólag hozzáértő személyzet szerelheti be és/vagy használhatja, az adott országnak megfelelő nyelven **1** **TELEPÍTÉSI KÉZIKÖNYV** és **2** **BIZTONSÁGI SZABÁLYOK** elolvasása és megértése után.

INFORMATION

Type

Rothoblaas
SIANK465

Related standard(s)

EN 795:2012 A+C
CEN/TS 16415:2013
UNI 11578:2015 A+C

Maximum number of users

4 users

Name or logo of manufacturer/distributor
ROTHOBLAAS

Serial number and year of manufacture

XX-YYYY (XX = lot number - YYYY = year)



PRODUCT INFORMATION

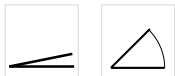

1.4301
AISI304
INOX



EN
795:2012
A+C

CEN/TS
16415:2013

UNI
11578:2015
A+C

SAFETY INSTRUCTIONS

- IS** Aðeins þjálfað starfsfólk má setja upp og/ða nota þessa Rotho Blaas-vöru eftir að hafa lesið og skilið **1** **UPPSETNINGARHANDBÓKAR** og **2** **REGLUGERDIR UM ÖRYGGI** á tungumáli þess lands sem varan er notuð í.
- LT** Produktą „Rotho Blaas” montuoti ir (arba) naudoti leidžiama tik patyrusiame personalui, prieš tai perskaicius ir supratus **1** **MONTAVIMO VADOVE** ir **2** **SAUGOS Taisyklės** atitinkamos šalies, kurioje eksploatuojama, kalba.
- LV** Rotho Blaas produktu uzstādīšana un/vai lietošana ir atļauta tikai pieredzējušam darbiniekam pēc **1** **UZSTĀDĪŠANAS ROKASGRĀMATĀ** un **2** **DROŠĪBAS NOTEIKUMU** izlasīšanas un izpratnes attiecīgās valsts valodā, kurā produkts tiks lietots.
- NL** De installatie en/of het gebruik van het product Rotho Blaas is voorbehouden aan uitsluitend vakbekwaam personeel dat de **1** **INSTALLATIEHANDLEIDING** en de **2** **VEILIGHEIDSVOORSCHRIFTEN** in de taal van het land van gebruik gelezen en begrepen heeft.
- NO** Dette Rotho Blaas-produktet skal bare installeres og/eller brukes av kvalifisert personell som har lest og forstått **1** **INSTALLASJONSHÅNDBOKEN** og **2** **SIKKERHETSFORSKRIFTENE**, på det språket som brukes i landet produktet anvendes.
- PL** Instalacji i/lub użytkowania produktu Rotho Blaas może dokonać wyłącznie doświadczony personel, który przeczytał i zrozumiał **1** **MANUAL DE INSTALAÇÃO** oraz normy **2** **BEZPIECZEŃSTWA** w języku krajowej użytkowania.
- RO** Instalarea și/sau utilizarea produsului Rotho Blaas este permisă numai personalului expert, după ce a citit și înțeles **1** **MANUALUL DE INSTALARE** și **2** **NORMELE DE SIGURANȚĂ** în limba țării de utilizare a produsului.
- SK** Inštalácia a/alebo používanie produktu Rotho Blaas je povolené len skúsenému personálu po predchádzajúcom prečítaní a pochopení **1** **NÁVODO NA INŠTALÁCIU** a **2** **BEZPEČNOSTNÝCH NORIEM** v jazyku príslušnej krajiny používania.
- SL** Ta proizvod Rotho Blaas lahko namesti in/ali uporablja samo izkušeno osebe, ki je prebralo in razume vse **1** **NAVODILIH ZA VGRADNJO** in **2** **VARNOSTNE PREDPIS** v jeziku države njegove uporabe.
- SV** Endast erfaren personal får installera och/eller använda den här Rotho Blaas-produkten efter att **1** **INSTALLATIONSANVISNINGARNA** och **2** **SÄKERHETSFORESKRIFTER** har lästs igenom på språket i installationslandet.
- TR** Sadece yetkili personel, **1** **KURULUM KILAVUZUNDA** ve **2** **GÜVENLİK MEVZUATINI** (2) ürünün kullandığı ülke dilinde okuyup anladktan sonra Rotho Blaas ürününü kurabilir ve/veya kullanabilir.
- JA** RothoBlaas製品の施工および使用は、資格を有する専門家のみに許可されています。施工および使用前に、必ず使用する国の言語で**1**設置マニュアルと**2**安全規則をお読み下さい。
- ZH** 只有具备合格资质的人员在阅读并理解以使用国的语言编写的**1**安装手册和**2**安全规程后才能安装和/或使用该Rotho Blaas产品。
- AR** يمكن فقط للفنيين المؤهلين باستخدام أو تركيب منتج Rotho Blaas بعد قراءة وفهم دليل التثبيت **1** نظراً السلامة **2** بلغة البلد المستخدم فيها المنتج

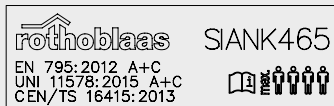
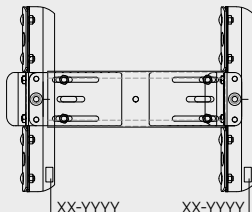

SIANK465 DIMENSIONS

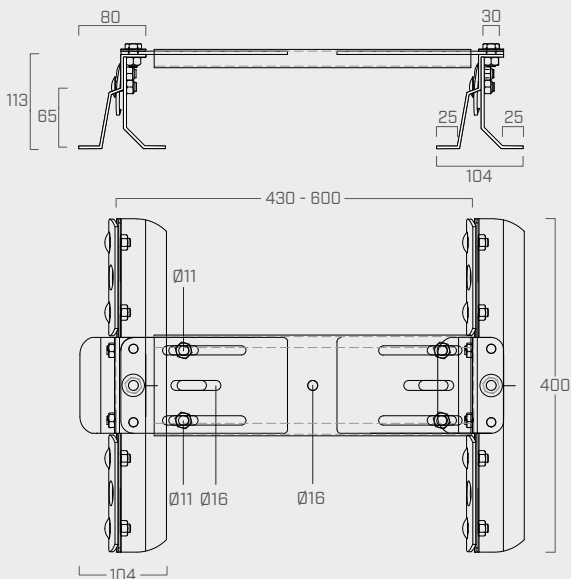

LOAD TEST MODEL

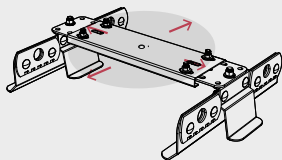

IT ⚠ Verificare idoneità statica del sottofondo di montaggio!

DE ⚠ Die statische Eignung des Montageuntergrundes sicherstellen!

EN ⚠ Check the static suitability of the installation substrate!

ES ⚠ ¡Compruebe la idoneidad estática del sustrato de montaje!

FR ⚠ Vérifier l'adéquation statique du substrat d'assemblage!

SIANK465 APPLICATION INSTRUCTIONS

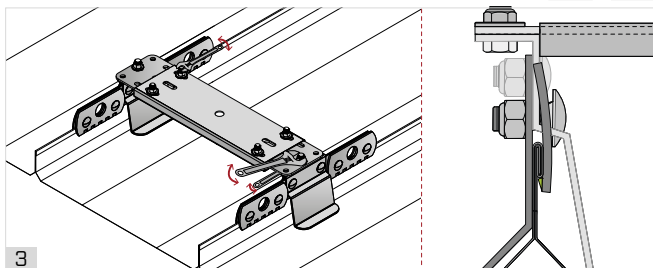
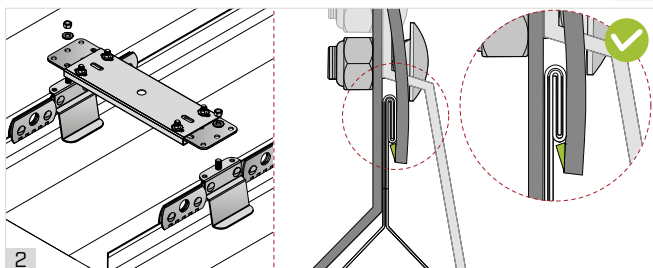
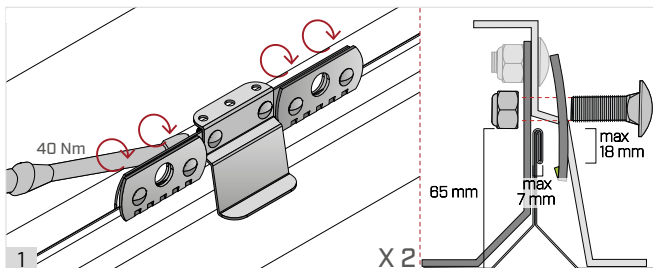

ANCHOR POINT

[EN 795:2012 A] [CEN/TS 16415:2013] [UNI 11578:2015 A]

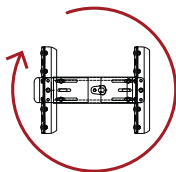

SIANK465 + AOS01



AOS01

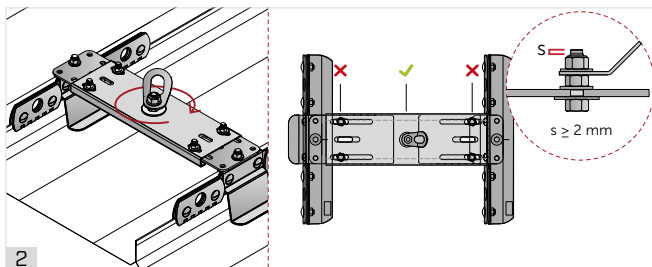
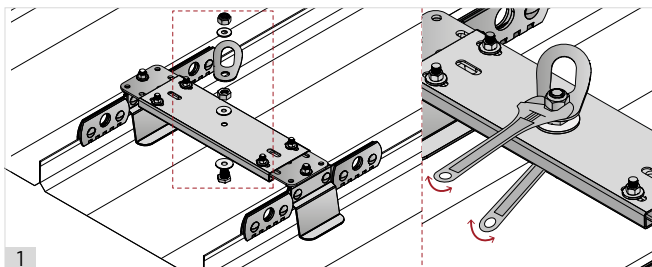

ANCHOR LINE

[EN 795:2012 C] [CEN/TS 16415:2013] [UNI 11578:2015 C]

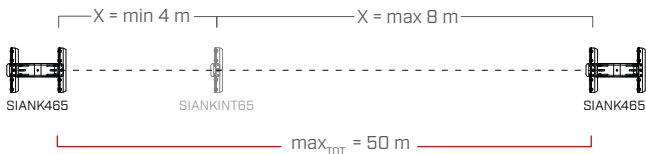

SIANK465 + PATROLERM



PATROL

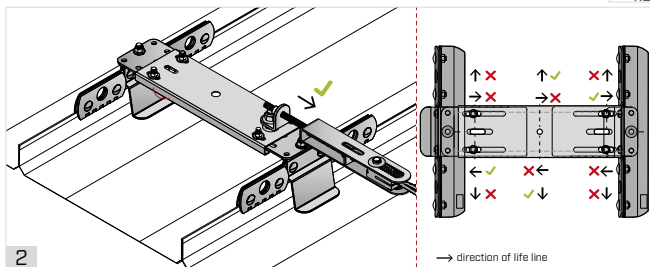
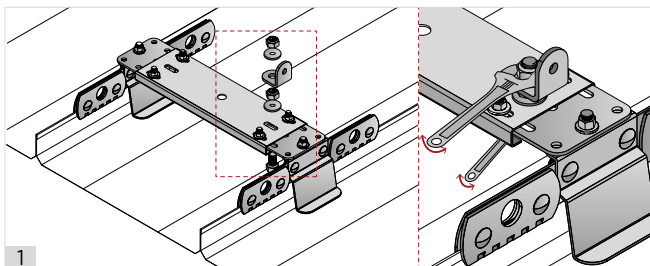

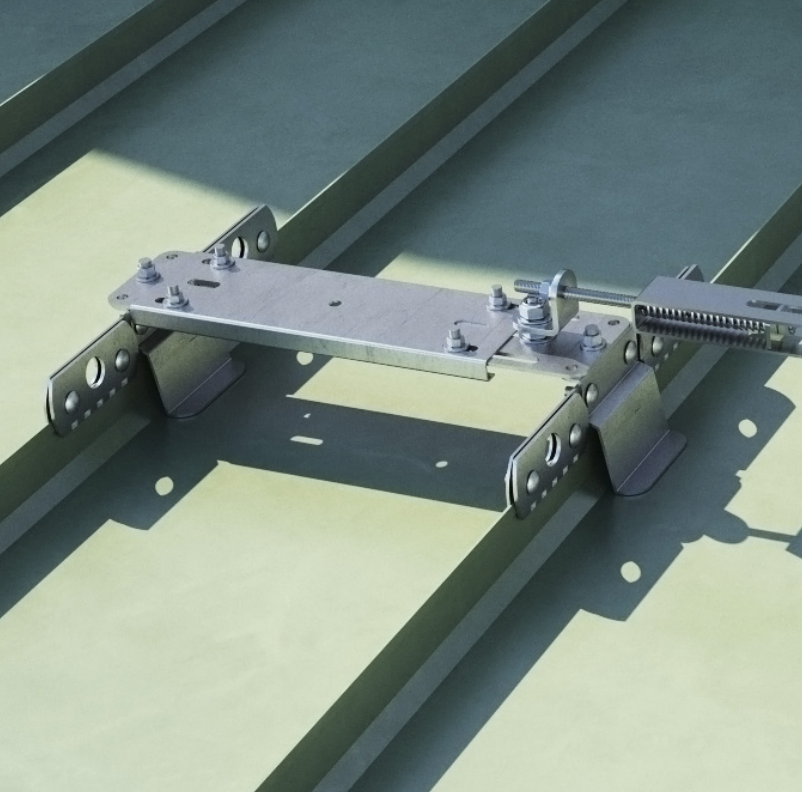

Rotho Blas SRL

Via dell'Adige N.2/1 | 39040, Cortaccia (BZ) | Italia
Tel: +39 0471 81 84 00 | Fax: +39 0471 81 84 84
info@rothoblaas.com | www.rothoblaas.com



88 SIANK465 03-21

